

Data Sheet



Article number: 04085774

Description: Stabilus Lift-O-Mat Gas Spring 085774 1900N
03 14 400 1900 Eyelet/Eyelet

Measures

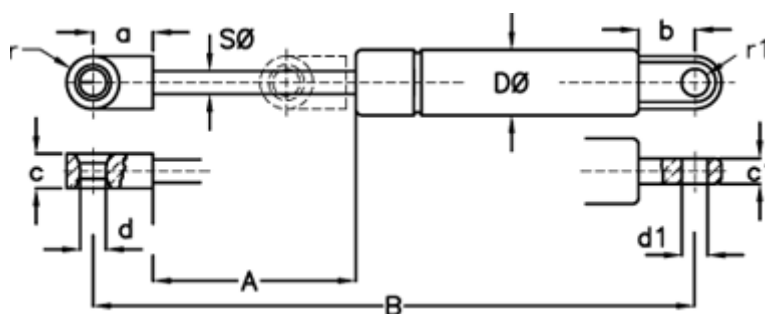

A = 400

a = 24

B = 900 +/-2

b = 15

c = 18

c1 = 8

d1 = 10,1 +0,1 -0,2

d = 10,1 +0,1

D = 28

Fixing = Øje/Øje

Material = Metal

Note = -

Note = -

r = 9

r1 = 8

S = 14